



Winkel / Verbinder / Halter

Angles / connectors / supports
Équerres / connecteurs / supports
Escuadras / placas de conexión / soportes

11/2021

K 11/21/4
Gruppe 4





Heilenbecker Straße 191-205,
58256 Ennepetal
Hauptverwaltung



Weichselstraße 9-11, 58256 Ennepetal
Logistikzentrum



Berliner Straße 50, 04910 Elsterwerda
Werk Elsterwerda



George/Südafrika
Vertriebsniederlassung Südafrika



D

VORMANN beschäftigt an seinen 3 deutschen Standorten etwa 190 Mitarbeiter. Das in der 5. Generation inhabergeführte Familienunternehmen bietet neben der Produktion und dem Vertrieb von Standardsortimenten im Bereich Verbindungselemente auch die Konzeption und Herstellung von Sonderanfertigungen an. VORMANN setzt bei der Produktion auf das Gütesiegel „Made in Germany“. Mit dem Erwerb der CE-Kennzeichnung für seine statisch relevanten Holzverbinder und Stützenschuhe bietet VORMANN mehr Transparenz im Hinblick auf Produktsicherheit und -qualität. Das schon vor Jahren eingeführte Qualitätsmanagement nach DIN EN ISO 9001:2015 mit regelmäßigen Auditierungen und Überprüfungen sorgt für gleichbleibende Qualität. Mit Gründung einer eigenen Vertriebsgesellschaft in George/Südafrika zur Jahrtausendwende gelingt VORMANN der Eintritt in einen neuen Markt.



F

VORMANN emploie quelque 190 personnes réparties sur un total de trois sites allemands. Parallèlement à la production et à la distribution de produits standard dans le domaine des éléments de fixation le entreprise familiale dirigée par ses propriétaires depuis cinq générations conçoit et fabrique également sur plan des produits sur mesure. Les produits VORMANN répondent au label de qualité « Made in Germany ». L'obtention du marquage CE pour ses raccords pour constructions en bois et ses supports d'ancrage aux propriétés statiques permet par ailleurs à VORMANN d'offrir une plus grande transparence concernant la qualité et la sécurité des produits. Nos processus de gestion de la qualité conformes à la norme DIN EN ISO 9001:2015, qui sont mis en œuvre depuis déjà de nombreuses années et incluent des audits et contrôles réguliers et garantissent une qualité constante. Avec la fondation de sa propre agence commerciale à George/Afrique du Sud au tournant du millénaire, VORMANN fait ainsi ses premiers pas sur un marché jusque-là peu connu.



GB

VORMANN employs roughly 190 associates at its 3 German facilities. The family-owned company, now managed by its owners in the 5th generation offers not only the production and sale of standard ranges in the area of fasteners but also the conception and production of custom-made products. In manufacturing VORMANN relies on the „Made in Germany“ quality seal. With the acquisition of the CE marking for its statically relevant timber connectors and supporting shoes, VORMANN offers more transparency with regard to product safety and quality. The quality management system according to DIN EN ISO 9001: 2015 with regular audits and inspections provides consistent quality. With the establishment of its own sales subsidiary in George/South Africa at the turn of the millennium, VORMANN successfully takes the first step into a previously little-known market.



E

VORMANN cuenta en sus 3 emplazamientos alemanas por unos 190 empleados. Esta empresa familiar, que ya se encuentra en su quinta generación ofrece además de la producción y venta de productos estándar en el área de los elementos de unión la concepción y fabricación de producciones especiales. VORMANN apuesta en su producción por el sello de calidad „Made in Germany“. Con la adquisición de el distintivo CE para sus uniones para madera y apoyos de importancia estática, VORMANN ofrecer más transparencia tanto lo que respecta a la seguridad y calidad de sus productos. El sistema de gestión de calidad introducido ya hace años conforme a la norma DIN EN ISO 9001:2015, con auditorías y controles periódicos, garantiza una calidad constante. Con el establecimiento de su propia filial de ventas en George/Sudáfrica a comienzos del milenio, VORMANN consigue con éxito adentrarse en un mercado hasta entonces poco conocido.

D	
Ausführungen	
B	braun
C	verchromt
GR	grau
RF	Edelstahl Rostfrei <i>Werkstoffangabe auf Anfrage</i>
RG	rostfrei Großpack
S	schwarz
SM	Stahl matt
V	vermessingt
W	weiß
WA	aluweiß
Z	verzinkt
ZF	feuerverzinkt
ZG	Großpack  Verkaufseinheit für Großverbraucher, Ware ist in Folie eingeschumpft.
ZL	verzinkt lose (Großpackung)
ZP / PR	Profipack  Einzelprodukte mit Kabelverbinder zu einer größeren Verkaufseinheit verbunden.

GB	
Surfaces	
B	brown
C	chromium-plated
GR	grey
RF	stainless steel <i>Steel grade information on request</i>
RG	stainless steel bulk packed
S	black
SM	steel mat
V	brassed
W	white
WA	aluwhite
Z	galvanized
ZF	hot galvanized
ZG	bulk packed  Packaging unit for large-quantity users. The goods come packed in shrink film.
ZL	galvanized (loose in bulk)
ZP / PR	industrial packaging  Individual products combined with cable connectors to form a larger-sized packaging unit.

F	
Exécutions	
B	brun
C	chromé
GR	gris
RF	acier inoxydable <i>Matériel en acier inoxydable sur demande</i>
RG	acier inoxydable en vrac
S	noir
SM	acier mat
V	laitonné
W	blanc
WA	aluminium blanc
Z	galvanisé
ZF	galvanisé par trempe
ZG	en vrac  Unité de vente pour gros utilisateurs, la marchandise est conditionnée sous film plastique.
ZL	galvanisé (en vrac)
ZP / PR	emballage industriel  Les produits sont reliés entre eux par un cordon plastifié pour former une unité de vente plus importante.

E	
Ejecución	
B	marrón
C	cromado
GR	gris
RF	acero inoxidable <i>Material de acero inoxidable bajo pedido</i>
RG	acero inoxidable a granel
S	negro
SM	acero mate
V	latonadas
W	blanco
WA	aluminio blanco
Z	galvanizado
ZF	galvanizado al fuego
ZG	a granel  Unidad de venta para grandes consumidores, la mercancía está empaquetada en lámina de contracción.
ZL	galvanizado (a granel)
ZP / PR	Embalaje industrial  Productos individuales con conectores de cable unidos en una unidad de venta mayor.

Technische Angaben

Artikel Nr.	Ausführung	GTIN 4003984	Abmessungen mm			ca. kg je VE	Schrauben		verp. zu... Stck.	 kg/ Stck.
			A	B	Stärke		Stck.	Ø mm		

termes techniques

Code Article	Exécutions	GTIN 4003984	dimension mm			env. kg p. VE	viss		emballé à ... pièces	 kg/ piece
			A	B	épaisseur		pièces	Ø mm		

Technische Angaben

versenkte Löcher
innen versenkte Löcher
beidseitig versenkte Löcher
gleichschenkelig
ungleichschenkelig
verstellbar
extra stark
Innenwinkel
Außenwinkel
Neigungswinkel

Technische und geschmackliche Änderungen vorbehalten.

Bei unseren Produktbildern in diesem Katalog handelt es sich um Abbildungsbeispiele. Die unterschiedlichen Abmessungen können von ihrer Beschaffenheit (Lochanzahl und -art, Oberfläche etc.) von den gezeigten Abbildungen abweichen!

technical terms

countersunk holes
holes countersunk from inside
holes countersunk from both sides
equal sided
unequal sided
adjustable
extra strong
inside bracket
outside bracket
angled brackets

We reserve the right to make alterations of a technical nature and concerning appearance.

The pictures of our articles in this catalogue are only samples. The different dimensions may differ in their character (quantity and type of holes, surface etc.) from the shown pictures.

technical terms

Item number	surfaces	GTIN 4003984	measurements mm			approx. kg p. VE	screws		packed as... pcs.	 kg/ pcs.
			A	B	thickness		pcs.	Ø mm		

términos técnicos

Número de artículo	Ejecución	GTIN 4003984	Dimensiones mm			approx. kgs. p. VE	viss		empaquetadas en... pza.	 kg/ pieza
			A	B	Espesor		Espesor	Ø mm		

termes techniques

trous noyés
trous noyés intérieurement
trous noyés des deux côtés
à ailes égales
à ailes inégales
réglable
extra-fort
angles intérieurs
angles extérieurs
angle d'inclinaison

Sous réserve de modifications techniques et concernant l'apparence.

Les images de nos articles dans ce catalogue ne sont que des échantillons. Les différentes dimensions peuvent varier selon certains critères (nombre et type de perçages, finition, etc.)

términos técnicos

agujeros embutidos
agujeros embutidos en el interior
agujeros embutidos en ambos lados
lados iguales
lados designates
ajustable
extra fuerte
ángulos internos
ángulos externos
ángulos de inclinación

Salvo modificaciones técnicas y estéticas.

Las imágenes de nuestros productos, mostradas en este catálogo, son meramente ilustrativas. Los productos pueden diferir en sus dimensiones (cantidad, tipo de agujeros, superficie, etc.) respecto a las imágenes mostradas.

Numerisches Inhaltsverzeichnis

Numerical list of contents
Table de matières numérique
Índice numérico

Inhaltsverzeichnis

List of contents
Table des matières
Índice

Order number Número de commande Número de pedido	page page pagina	Order number Número de commande Número de pedido	page page pagina
000075	26	001475	24
000076	26	001476	24
000160	9	001477	25
000162	10	001478	24
000163	14	001601	18
000165	10/11	006010-	
000168	26	006012	28
000169	26	006013	28
000170	26	006017	28
000171	8	006020	28
000172	8	006021	28
000173	7	006022	29
000174	11/12/14/30	006027	29
000175	9	006030	29
000176	9	006111	29
000177	7/30	006121	29
000178	9	010075	26
000179	8/30	010165	10
000180	6/30	010177	7
000181	6/30	010179	8
000182	7/30	010180	6
000183	14/30	010183	14
000184	15	010188	13
000185	11	010255	27
000186	13	010290	25
000187	13	011401	17
000188	13	011403	17
000189	12	071200	9
000242	25	090275	12
000254	27	091910-	
000270	27	091914	6
000272	15	092120-	
000273	15	092125	11
000276	19/30	092126-	
000277	19/30	092130	13
000280	27	098001-	
000283	27	098012	18
000292	24		
000330	16		
000350	29		
001401-			
001403	17		
001440	18		
001450-			
001455	20		
001456-			
001461	21		
001462-			
001466	21/22		
001467	22		
001469	23		
001470-			
001472	23		



	Seite page pagina
Abstandshalter	18
Aufhängewinkel	27
Aufhängungen	27
Balkenwinkel	7-8/30
Bodenträgerwinkel	12
Bolzenverbinder	27
Breitwinkel	7-8/30
Eckwinkel	13
Edelstahl-Aufhängelaschen	27
Edelstahl-Balkenwinkel	8
Edelstahl-Winkel	6/7/13
und Verbinder	14
Ersatzschnäpper Festzeltgarnitur	25
Flachwinkel	13
Gardinenwinkel	9
Groß- und Profipackungen	30
Halterungs-Set Festzeltgarnitur	25
Handlaufstützen	28-29
Hessenkrallen	15
Leiter- und Gerätehalter	18
Manschetten-Haken	24
Möbelwinkel	11+13/30
Montagebänder	17
Ösenplatten	26
Piconect-Verbinder	14
Piconect-Winkel	10
Riegelschlaufen	26
Rohrschellen	26
Spanplattenhalter	12
Spanplattenwinkel	12/30
Stuhlwinkel	6/30
T-Flachwinkel	12
Universal-Abstandsverbinder	16
Universalhaken	20-24
Universalhalter	25
Vario-Verbindungsbleche	14/15
Verbindungsbleche	14+15/30
Verstellwinkel	9/11 20/23/24/
Wandhaken	27
Winkel	6-15
Zaunriegelhalter	24
spacers	18
suspension angles	27
suspensions	27
beam angles	7-8/30
shelf supports	12
bolt connectors	27
wide angles	7-8/30
corner angles	13
stainless steel suspension shackles	27
stainless steel beam angles	8
stainless steel angles	6/7/13
and connectors	14
catch for marquee set	25
flat angles	13
curtain angles	9
bulk and industrial packs	30
support set	25
handrail supports	28-29
bent grips	15
ladder- and tool-supports	18
swing clamps	24
furniture angles	11+13/30
fitting strips	17
eyelet plates	26
"Piconect" connectors	14
"Piconect" angles	10
bolt loops	26
pipe clips	26
particle board supports	12
particle board angles	12/30
chair angles	6/30
T-shaped flat angles	12
all-purpose space connectors	16
universal hooks	20-24
all-purpose supports	25
variable connecting plates	14/15
connecting plates	14+15/30
adjustable angles	9/11 20/23/24/
wall hooks	27
angles	6-15
lock bracket	24



entretoises d'ecartement	distanciadores	18
équerres d'ecartement	escuadras de suspension	27
suspensions	suspensiones	27
équerres de poutre	escuadras para vigas	7-8/30
équerres pour fixation d'etageres	soportes para estante	12
ferrures de connexion à vis	uniones de bulón	27
équerres larges	escuadras anchas	7-8/30
équerres d'angle	ángulos de esquina	13
étriers de suspension en acier inoxydable	corchetes de suspension de acero inoxidable	27
équerres de poutre en acier inoxydable	angulares para vigas de acero inoxidable	8
équerres et	angulares y placas de	6/7/13
connecteurs en acier inoxydable	connexión de acero inoxidable	14
loqueteau de blocage pour mobilier de barnums	pestillo para accesorios para carpas fijas	25
étriers de suspension en acier inoxydable	angulares planos	13
équerres pour tringles à rideaux	escuadras para cortinas	9
en vrac et emballage industriel	a granel y embalaje industrial	30
sets de support	kits de soportes	25
supports de main courante	soportes de pasamanos	28-29
plaques étroite à griffes	garras „Hessen“	15
supports échelles et objets encombrants	soportes para escaleras y utensilios	18
mousquetons sur bague	abrazaderas con gancho basculante	24
équerres de meubles	escuadras para muebles	11+13/30
feuillards multi-usage	cintas de montaje	17
plaques à oeillet	placas con ojetas	26
plaques de connexion "Piconect"	uniones plana "Piconect"	14
équerres „Piconect“	escuadras "Piconect"	10
pattes à gâche	argollas para cerrojos	26
pattes à collier	abrazaderas	26
supports pour panneau de particules	soportes para tableros de virutas	12
équerres pour panneau de particules	escuadras para tableros de virutas	12/30
équerres de chaise	escuadras para sillas	6/30
plaques de connexion en T	ángulos planos en T	12
suspents en universel	elementos de unión universales	16
crochets universels	ganchos universales	20-24
supports universels	soportes universales	25
plaques de connexion ajustables	chapas de unión vario	14/15
plaques de connexion	chapas de unión	14+15/30
équerres ajustables	escuadras ajustables	9/11 20/23/24
crochets muraux	ganchos de pared	27
équerres	angulares	6-15
support de verrou	soporte de la barra	24

Stuhlwinkel

innen versenkt



Stck./Karte	
	4
	4
	4
	4



Starke Stuhlwinkel

innen versenkt



Artikel-Nr.	Ausführung	GTIN 4003984	Abmessungen mm			ca. kg je VE	Schrauben		verp. zu... Stck.
			A	B	Stärke		Stck.	Ø mm	
000180025Z		200233	25	15	2,0	1,03	4	3,5	100
000180030Z		200257	30	15	2,0	1,32	4	3,5	100
000180040Z		200271	40	15	2,0	1,67	4	3,5	100
000180050Z		200295	50	15	2,0	2,12	4	3,5	100
000180060Z		200318	60	18	2,0	3,05	4	3,5	100
000180080Z		200332	80	18	2,0	2,18	4	4,0	50
000180100Z		200356	100	20	2,0	2,90	6	4,0	50
000180120Z		200370	120	20	2,0	3,71	6	4,0	50
000180050ZL		200301	50	15	2,0	10,53	4	3,5	500
000180025ZP		201827	25	15	2,0	1,24	VE 10 à 12 Stck.		
000180030ZP		201834	30	15	2,0	1,51	VE 10 à 12 Stck.		
000180040ZP		201841	40	15	2,0	2,02	VE 10 à 12 Stck.		
000180050ZP		201858	50	15	2,0	2,61	VE 10 à 12 Stck.		
000180060ZP		201865	60	18	2,0	2,45	VE 10 à 8 Stck.		
000180080ZP		201889	80	18	2,0	3,46	VE 10 à 8 Stck.		

ZP= **PROFI-PACK (Programmübersicht siehe Seite 30)**

000180025ZG		202008	25	15	2,0	0,51	VE 1 à 50 Stck.		
000180040ZG		202015	40	15	2,0	0,83	VE 1 à 50 Stck.		
000180050ZG		202022	50	15	2,0	1,07	VE 1 à 50 Stck.		
000180060ZG		202039	60	18	2,0	1,50	VE 1 à 50 Stck.		

ZG= **GROSS-PACK (Programmübersicht siehe Seite 30)**

000180025B		190138	25	15	2,0	0,52	4	3,5	50
000180040B		190152	40	15	2,0	0,82	4	3,5	50
000180050B		190176	50	15	2,0	1,12	4	3,5	50
000180025W		190145	25	15	2,0	1,06	4	3,5	100
000180040W		190169	40	15	2,0	1,69	4	3,5	100
000180050W		190183	50	15	2,0	1,13	4	3,5	50
000180060W		190206	60	18	2,0	1,67	4	3,5	50
000180080W		190220	80	18	2,0	2,20	4	4,0	50
010180025		180115	25	15	2,0	0,51	4	3,0	50
010180040		180122	40	15	2,0	0,86	4	3,0	50
010180050		180139	50	15	2,0	1,08	4	3,5	50
010180060		180146	60	18	2,0	1,62	4	3,5	50
010180080		180153	80	18	2,0	2,21	4	3,5	50
010180100		180160	100	20	2,0	3,10	6	3,5	50
091910000		510059	25	15	2,0	0,30	4	3,0	5
091912000		510066	40	15	2,0	0,45	4	3,0	5
091913000		510073	50	15	2,0	0,58	4	3,5	5
091914000		510080	60	18	2,0	0,78	4	3,5	5

ZP= **PROFI-PACK (Programmübersicht siehe Seite 30)**

000181100Z		200394	100	20	2,5	1,53	6	4,0	20
000181125Z		200400	125	22	2,5	2,18	6	4,0	20
000181150Z		200417	150	25	3,0	3,39	6	4,5	20
000181100B		190237	100	20	2,5	1,57	6	4,0	20
000181100ZP		201902	100	20	2,5	5,95	VE 10 à 8 Stck.		

Artikel-Nr.	Ausführung	GTIN 4003984	Abmessungen mm			ca. kg je VE	Schrauben		verp. zu... Stck.
			A	B	Stärke		Stck.	Ø mm	
000177030Z		200141	30	30	2,0	1,36	4	3,5	50
000177040Z		200158	40	40	2,0	2,34	4	3,5	50
000177050Z		201933	50	50	2,0	3,72	6	3,5	50
000177060Z		200165	60	60	2,0	2,17	8	3,5	20
000177030B		190039	30	30	2,0	0,55	4	3,5	20
000177040B		190053	40	40	2,0	0,95	4	3,5	20
000177060B		190077	60	60	2,0	2,13	8	3,5	20
000177030S		190831	30	30	2,0	1,40	4	3,5	50
000177040S		190848	40	40	2,0	2,33	4	3,5	50
000177050S		190855	50	50	2,0	3,72	6	3,5	50
000177060S		190862	60	60	2,0	2,18	8	3,5	20
000177030W		190046	30	30	2,0	1,40	4	3,5	50
000177040W		190060	40	40	2,0	2,33	4	3,5	50
000177060W		190794	60	60	2,0	2,18	8	3,5	20
000177030ZP		201957	30	30	2,0	1,94	6 à 12 Stck.		4 à 12 Stck.
000177040ZP		201964	40	40	2,0	2,19			

ZP=  **PROFI-PACK (Programmübersicht siehe Seite 30)**

010177030		180641	30	30	2,0	0,55	4	3,5	20
010177040		180603	40	40	2,0	0,94	4	3,5	20



Breitwinkel
beidseitig versenkt



000182040Z		201193	40	20	3,0	0,34	4	4,5	10
000182060Z		201209	60	20	3,0	0,52	4	4,5	10
000182080Z		200424	80	20	5,0	1,11	4	5,0	10
000182100Z		200431	100	20	5,0	1,38	4	5,0	10
000182120Z		200448	120	20	5,0	1,70	4	6,0	10
000182140Z		200455	140	20	5,0	1,99	4	6,0	10
000182160Z		200462	160	20	5,0	2,16	6	6,0	10
000182180Z		200479	180	20	5,0	2,48	6	6,0	10
000182100W		190268	100	20	5,0	1,39	4	5,0	10
000182120W		190282	120	20	5,0	1,68	4	6,0	10

000182040ZP		201988	40	20	3,0	1,55	6 à 8 Stck.		6 à 8 Stck.
000182060ZP		201995	60	20	3,0	2,42			

ZP=  **PROFI-PACK (Programmübersicht siehe Seite 30)**



Starke Winkel
innen versenkt

000173007Z		201773	150	25	5,0	5,15	6	6,0	20
------------	--	--------	-----	----	-----	------	---	-----	----



Starke Winkel
innen versenkt

000173100Z		201162	100	40	5,0	2,84	4	6,0	10
000173150Z		201179	150	40	5,0	4,14	6	6,0	10
000173200Z		201186	200	40	5,0	5,65	8	6,0	10



Starke Balkenwinkel
innen versenkt

Starke Winkel

ungleichschenlig,
innen versenkt

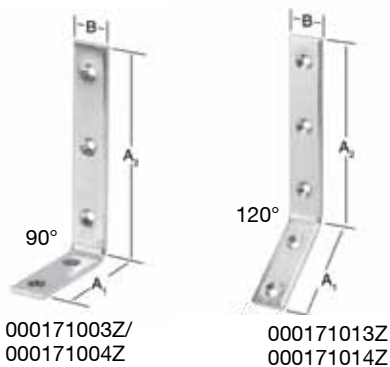

Artikel-Nr.	Ausführung	GTIN 4003984	Abmessungen mm			ca. kg je VE	Schrauben		verp. zu... Stck.
			A ₁ A ₂	B ₁ B ₂	Stärke		Stck.	Ø mm	
000171003Z		201759	80 150	25	5,0	3,90	5	6,0	20
000171004Z		201766	110 150	25	5,0	4,43	5	6,0	20
000171013Z		201728	80 150	25	5,0	4,10	5	6,0	20
000171014Z		201735	110 150	25	5,0	4,62	5	6,0	20

Starke Winkel

ungleichschenlig,
innen versenkt



000171100Z		201131	100 50	40	4,8	2,07	4	6,0	10
000171150Z		201148	150 75	40	4,8	3,19	5	6,0	10
000171200Z		201155	200 100	40	4,8	4,16	7	6,0	10

Breitwinkel

ungleichschenlig,
innen versenkt



000172075Z		200080	75	40 25	2,0	1,40	5	4,5	20
000172115Z		200097	115	60 40	2,5	4,22	8	4,5	20

Starke Balkenwinkel

ungleichschenlig,
innen versenkt



000179080Z		201216	80 40	30	2,0	1,09	5	4,0	20
000179100Z		200189	100 75	30	3,0	1,21	5	4,0	10
000179120Z		200202	120 80	35	4,0	2,02	9	5,0	10
000179180Z		200219	180 120	40	5,0	4,15	7	6,0	10
000179240Z		200226	240 160	50	5,0	7,10	10	6,0	10
000179080B		190749	80 40	30	2,0	1,09	5	4,0	20
000179100B		190091	100 75	30	3,0	1,21	5	4,0	10
000179120B		190107	120 80	35	4,0	1,98	9	5,0	10
000179180B		190114	180 120	40	5,0	4,32	7	6,0	10
000179080S		190886	80 40	30	2,0	1,12	5	4,0	20
000179100S		190893	100 75	30	3,0	1,21	5	4,0	10
000179120S		190909	120 80	35	4,0	1,97	9	5,0	10
000179180S		190916	180 120	40	5,0	4,24	7	6,0	10
000179080W		190756	80 40	30	2,0	1,12	5	4,0	20
000179100W		190763	100 75	30	3,0	1,21	5	4,0	10
000179120W		190770	120 80	35	4,0	1,97	9	5,0	10
000179180W		190787	180 120	40	5,0	4,24	7	6,0	10
000179100ZP		201971	100 75	30	3,0	5,73	6 à 8 Stck.		



ZP= PROFI-PACK (Programmübersicht siehe Seite 30)

010179080		180689	80 40	30	2,0	0,56	5	4,0	10
010179100		180672	100 75	30	3,0	1,20	5	4,0	10

Artikel-Nr.	Ausführung	GTIN 4003984	Abmessungen mm			ca. kg je VE	Schrauben		verp. zu... Stck.
			A ₁ A ₂	B ₁ B ₂	Stär- ke		Stck.	Ø mm	
000160095Z		200011	99 55	13,5	3,5	1,00	3 rd. 1 ov.	4,0 5,0	20
000160120Z		200035	120 60	17	3,5	1,51	4 rd. 1 ov.	4,0 6,0	20
000160180Z		200042	180 60	17	3,5	2,11	4 rd. 1 ov.	4,0 6,0	20
000160095W		190695	99 55	13,5	3,5	1,01	3 rd. 1 ov.	4,0 5,0	20
000160120W		190701	120 60	17	3,5	1,52	4 rd. 1 ov.	4,0 6,0	20
000160180W		190718	180 60	17	3,5	2,08	4 rd. 1 ov.	4,0 6,0	20



Gardinen- winkel

000178080Z		200172	80 65	20	4,0	1,51	2 rd. 1 ov.	6,0 6,0	20
000178080W		190732	80 65	20	4,0	1,49	2 rd. 1 ov.	6,0 6,0	20
000178080S		190879	80 65	20	4,0	1,49	2 rd. 1 ov.	6,0 6,0	20

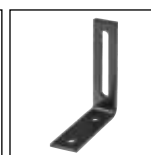

Verstellwinkel

Langloch:
52 x 6,5 mm

000175070Z		200127	70 50	35 50	2,0	1,64	7 rd. 2 ov.	4,5 4,5	20
000175070W		190435	70 50	35 50	2,0	1,69	7 rd. 2 ov.	4,5 4,5	20
071200000RF		380348	70 50	35 50	2,0	0,87	7 rd. 2 ov.	4,5 4,5	10



Verstellwinkel

innen versenkt

Langloch:
30 x 5,5 mm

000176075Z		200134	75 35	65	3,5	1,58	3 rd. 4 ov.	6,0 6,0	10
------------	--	--------	----------	----	-----	------	----------------	------------	----

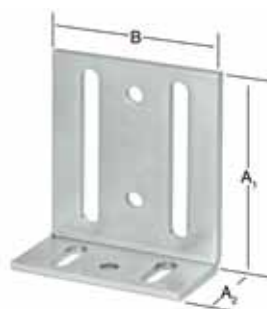

Starke Verstellwinkel

Langloch:
59,5 x 7 mm

3F-Winkel (Konsolen)

innen versenkt



Artikel-Nr.	Ausführung	GTIN 4003984	Abmessungen mm			ca. kg je VE	Schrauben		verp. zu... Stck.	kg Stck.
			A	B	C		Stck.	Ø mm		
000165115B		250139	115	80	40	1,15	4	4,0	10	20
000165160B		250184	160	105	40	1,70	4	4,0	10	25
000165235B		250894	235	160	40	2,64	4	4,0	10	25
000165315B		250948	315	200	40	2,26	4	4,0	6	30
000165115C		250153	115	80	40	1,15	4	4,0	10	20
000165160C		250207	160	105	40	1,72	4	4,0	10	25
000165235C		250900	235	160	40	2,63	4	4,0	10	25
000165315C		250955	315	200	40	3,67	4	4,0	10	30
000165115GR		251778	115	80	40	1,13	4	4,0	10	20
000165160GR		251747	160	105	40	1,69	4	4,0	10	25
000165235GR		251754	235	160	40	2,64	4	4,0	10	25
000165315GR		251761	315	200	40	2,26	4	4,0	6	30
000165115S		251051	115	80	40	1,14	4	4,0	10	20
000165160S		251068	160	105	40	1,69	4	4,0	10	25
000165235S		251075	235	160	40	2,65	4	4,0	10	25
000165315S		251570	315	200	40	2,25	4	4,0	6	30
000165115SM		251808	115	80	40	1,16	4	4,0	10	20
000165160SM		251792	160	105	40	1,70	4	4,0	10	25
000165235SM		251785	235	160	40	2,66	4	4,0	10	25
000165115W		250177	115	80	40	1,14	4	4,0	10	20
000165160W		250221	160	105	40	1,69	4	4,0	10	25
000165235W		250931	235	160	40	2,65	4	4,0	10	25
000165315W		250986	315	200	40	3,65	4	4,0	10	30
000165115Z		251693	115	80	40	1,13	4	4,0	10	20
000165160Z		251709	160	105	40	1,71	4	4,0	10	25
010165160	Rostfrei V2A	271882	160	105	40	1,71	4	4,0	10	25
010165235		271875	235	160	40	2,65	4	4,0	10	25

3F-Winkel (Konsolen)

innen versenkt



Artikel-Nr.	Ausführung	GTIN 4003984	Abmessungen mm			ca. kg je VE	Schrauben		verp. zu... Stck.
			A	B	Stärke		Stck.	Ø mm	
000165040S		251044	40/25	70	1,5	0,99	5	4,0	20
000165040W		250122	40/25	70	1,5	0,50	5	4,0	10
000165040Z		251716	40/25	70	1,5	0,98	5	4,0	20

Piconect- Winkel

innen versenkt

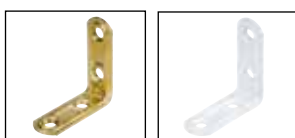

000162030C		201667	30	15	1,5	1,06	4	3,5	100
000162040C		201629	40	15	1,5	1,34	4	3,5	100
000162050C		201612	50	15	1,5	0,37	4	3,5	20
000162030V		201674	30	15	1,5	1,05	4	3,5	100
000162040V		201636	40	15	1,5	1,37	4	3,5	100
000162050V		201599	50	15	1,5	1,71	4	3,5	100
000162030W		190657	30	15	1,5	1,10	4	3,5	100
000162040W		190633	40	15	1,5	1,33	4	3,5	100
000162060W		190565	60	15	1,5	2,12	4	3,5	100

Artikel-Nr.	Ausführung	GTIN 4003984	Abmessungen mm			ca. kg je VE	Schrauben		verp. zu... Stck.
			A	B	Stärke		Stck.	Ø mm	
000185025Z		200660	25	10	2,0	0,71	4	3,0	100
000185030Z		200707	30	10	2,0	0,95	4	3,0	100
000185040Z		200745	40	10	2,0	1,16	4	3,0	100
000185040V		200721	40	10	2,0	1,15	4	3,0	100
092120000	V	450126	25	10	2,0	0,25	4	3,0	5
092121000	V	450133	30	10	2,0	0,29	4	3,0	5
092122000	V	450140	40	10	2,0	0,33	4	3,0	5
092123000	V	450157	50	10	2,0	0,32	4	3,0	5
092124000	Z	450799	30	10	2,0	0,29	4	3,0	5
092125000	Z	450782	40	10	2,0	0,34	4	3,0	5



Winkel

Angles
Équerres
Escuadras

Möbelwinkel

beidseitig versenkt

Stck./Karte

4
4
4
4
4
4



000165025B		250054	25	30	1,0	0,59	3	4,0	50
000165025S		251037	25	30	1,0	0,59	3	4,0	50
000165025V		250658	25	30	1,0	0,30	3	4,0	25
000165025W		250085	25	30	1,0	0,30	3	4,0	25
000174002Z		200110	25	30	1,0	0,30	3	4,0	25
000174002ZP		201940	25	30	1,0	0,80	6 à 12 Stück		

ZP= **PROFI-PACK (Programmübersicht siehe Seite 30)**



Verstellwinkel

innen versenkt

000174001Z		200103	39 28	22	1,0	0,27	2	4,0	25
000174001W		190725	39 28	22	1,0	0,28	2	4,0	25



Verstellwinkel

innen versenkt

**Spanplatten-
winkel**

innen versenkt

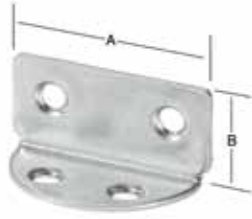

Artikel-Nr.	Ausführung	GTIN 4003984	Abmessungen mm			ca. kg je VE	Schrauben		verp. zu... Stck.
			A	B	Stärke		Stck.	Ø mm	
000174005Z		202046	40	19	1,5	0,38	4	3,5	25
000174005ZP		202084	40	19	1,5	1,72	VE 10 à 12 Stck.		

ZP= PROFI-PACK (Programmübersicht siehe Seite 30)

**Bodenträger-
winkel**

innen versenkt

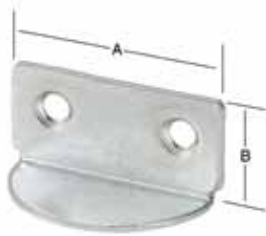

000174006Z		202053	40	19	1,5	0,40	2	3,5	25
------------	--	--------	----	----	-----	------	---	-----	----

**Spanplatten-
halter**

außen versenkt
mit zusätzlichem
Langloch



000174010Z		202060	40	19	1,5	0,60	4 rd. 1 ov.	3,5	25
------------	--	--------	----	----	-----	------	----------------	-----	----

T-Flachwinkel

versenkte Löcher

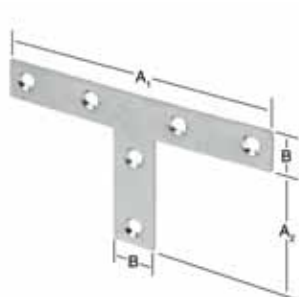

000189075Z		201124	A ₁ 70 A ₂ 36	16	1,5	0,96	6	3,0	50
000189125Z		201223	120 54	19	1,5	0,75	6	4,0	20
000189140Z		201926	140 80	30	2,0	2,07	6	4,0	20

Artikel-Nr.	Ausführung	GTIN 4003984	Abmessungen mm			ca. kg je VE	Schrauben		verp. zu... Stck.
			A	B	Stärke		Stck.	Ø mm	
000186030Z		200868	30	10	1,5	0,59	4	2,5	100
000186040Z		200905	40	10	1,5	0,83	4	2,5	100
000186050Z		200943	50	10	1,5	1,11	4	2,5	100
000186060Z		200981	60	10	1,5	1,27	4	2,5	100
000186075Z		201018	75	12	1,5	2,00	4	3,0	100
092126000	Z	450164	30	10	1,5	0,22	4	2,5	5
092127000	Z	450171	40	10	1,5	0,27	4	2,5	5
092128000	Z	450188	50	10	1,5	0,32	4	2,5	5
092129000	Z	450195	60	10	1,5	0,39	4	2,5	5
092130000	Z	450201	75	12	1,5	0,49	4	3,0	5

**Möbel-
Flachwinkel**

Stck./Karte

- 4
- 4
- 4
- 4
- 4

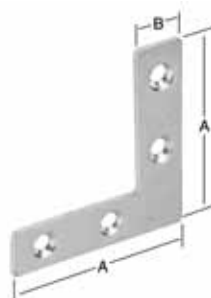

000187100Z		201032	100	15	1,5	0,71	5	3,0	20
000187120Z		201056	120	20	2,0	1,37	5	3,5	20
000187160Z		201070	160	22	2,5	2,50	6	4,0	20
000187200Z		201087	200	30	3,0	4,93	6	6,0	20
000187250Z		201094	250	30	3,5	3,20	5	6,0	10
000187100B		190367	100	15	1,5	0,68	5	3,0	20
000187100W		190374	100	15	1,5	0,68	5	3,0	20
000187100S		190817	100	15	1,5	0,68	5	3,0	20
000187120S		190824	120	20	2,0	1,37	5	3,5	20

Eckwinkel

versenkte Löcher



000188100Z		201100	100	15	1,5	0,69	5	3,5	20
000188120Z		201117	120	20	2,0	1,37	5	3,5	20
010188120		180597	120	20	2,0	1,34	5	3,5	20

Eckwinkel

versenkte Löcher



Vario-Verbindungsbleche

versenkte Löcher



Artikel-Nr.	Ausführung	GTIN 4003984	Abmessungen mm			ca. kg je VE	Schrauben		verp. zu... Stck.
			A	B	Stärke		Stck.	Ø mm	
000174003Z		201681	63	22	1,0	0,26	2	4,0	25

Piconect Verbinder

versenkte Löcher

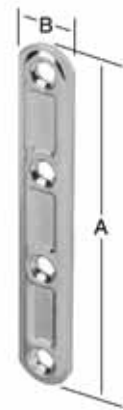

000163100C		201483	100	15	1,5	0,35	4	3,5	20
000163100V		201490	100	15	1,5	0,34	4	3,5	20

Verbindungsbleche

versenkte Löcher

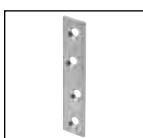
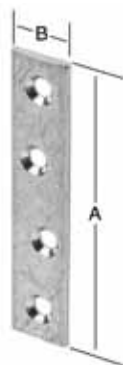

000183040Z		200486	40	15	2,0	0,94	2	3,0	100
000183050Z		200509	50	15	2,0	1,04	2	3,0	100
000183060Z		200523	60	15	2,0	1,26	2	3,5	100
000183080Z		200547	80	15	2,0	1,63	4	3,5	100
000183100Z		200561	100	15	2,0	2,16	4	3,5	100
000183120Z		200585	120	18	2,0	3,07	4	3,5	100
000183200Z		200608	200	20	2,0	6,07	4	4,0	100
000183080ZP		202091	80	15	2,0	1,32	4	3,5	10 à 8
000183100ZP		202107	100	15	2,0	1,75	4	3,5	10 à 8

ZP=  **PROFI-PACK (Programmübersicht siehe Seite 30)**

010183100		180177	100	15	2,0	1,09	4	3,5	50
-----------	---	--------	-----	----	-----	------	---	-----	----

Artikel-Nr.	Ausführung	GTIN 4003984	Abmessungen mm			ca. kg je VE	Schrauben		verp. zu... Stck.
			A	B	Stärke		Stck.	Ø mm	
000184170Z 000184190Z		200622	170	30	3,0	5,91	6	4,0	50
		200639	190	35	4,0	3,94	9	5,0	20

Verbindungsbleche

versenkte Löcher

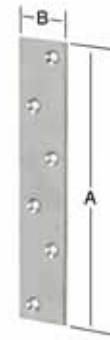

000184140Z		200615	140	20	4,0	3,66	2 rd. 1 ov.	6,0 6,0	50
------------	--	--------	-----	----	-----	------	----------------	------------	----

Vario-Verbindungsbleche

Langloch:
52 x 6,5 mm

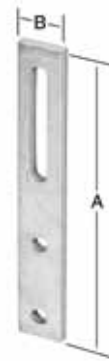

000272140Z		290401	140	20	1,0	0,67	-	-	25
------------	--	--------	-----	----	-----	------	---	---	----

Hessenkrallen

zur
Holzfenstermontage
sendzimir verzinkt



000273140Z		290609	140	25	2,0	4,83	-	-	100
------------	--	--------	-----	----	-----	------	---	---	-----

Hessenkrallen

zur
Holzfenstermontage
sendzimir verzinkt



Universal-Abstandsverbinder

All-purpose space connectors
Connecteurs universels
Distanciadores elementos de unión universales



Problemloses Verkleiden von Rohren und Leitungen.

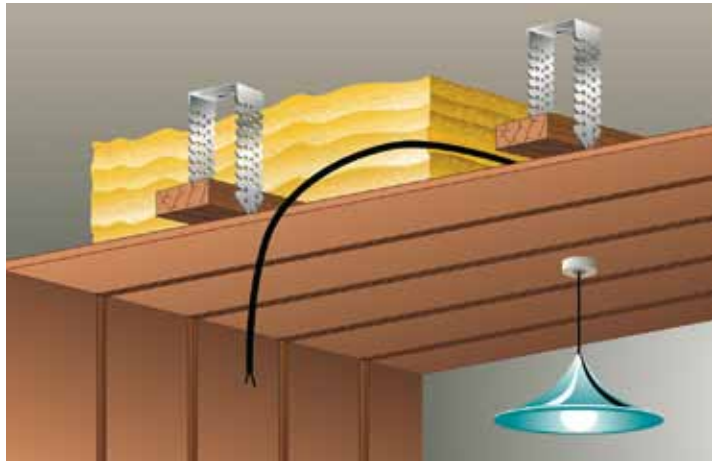

Perfektes Abhängen und Isolieren von Decken.



Millimetergenaues Ausgleichen unebener Wände.

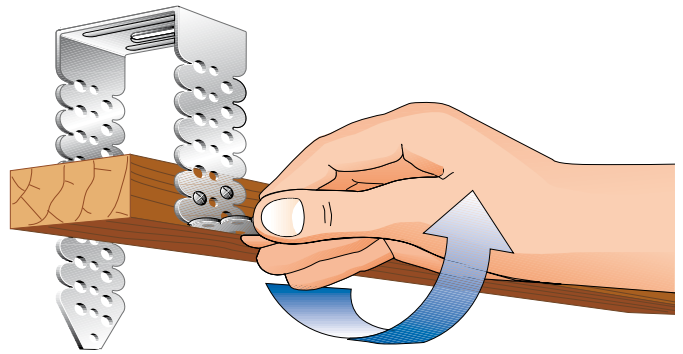

Beide Standardgrößen lassen sich individuell verkürzen – über die Lattung hinausragendes Material einfach umbiegen (vorgestanzte Knickstellen).

Universal-Abstandsverbinder

sendzimir verzinkt

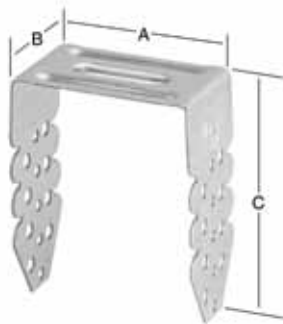

Artikel-Nr.	Ausführung	GTIN 4003984	Abmessungen mm			ca. kg je VE	Schrauben		verp. zu... Stck.
			A	B	C		Stck.	Ø mm	
000330065PR		290784	48	30	65	2,14	-	4,0/3,0	6 à 10
000330125PR		290760	48	30	125	3,49	-	4,0/3,0	6 à 10

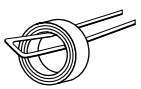

– platzsparend und
umweltfreundlich
präsentiert

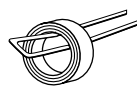

– ideal für den Verkauf in offener
Warenpräsentation an Industrie,
Handwerk und Hobby

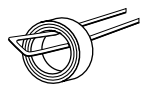

– als gebundene Rolle
ohne Umverpackung

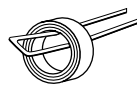

– in vielen Ausführungen
und Größen.

Artikel-Nr.	GTIN 4003984	Abmess. mm	Länge auf Rollen	ca. kg je VE	verp. zu... Stck.
001401012ZF	290357	12 x 0,9	3 m	1,74	10 à 3 m
001401012W	290371	12 x 0,9	1,5 m	0,95	10 à 1,5 m
001403012ZF	290333	12 x 0,9	10 m	3,15	5 à 10 m



Abmessung: 12 mm

Montage-
band

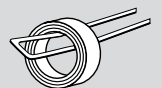

001401016ZF	290388	16 x 0,9	3 m	2,65	10 à 3 m
001401016W	290340	16 x 0,9	1,5 m	1,38	10 à 1,5 m
001403016ZF	290265	16 x 0,9	10 m	4,67	5 à 10 m
011401016	180528	16 x 0,9	3 m	1,37	5 à 3 m
011403016	180443	16 x 0,9	10 m	0,90	1 à 10 m



V2A



Abmessung: 16 mm

Montage-
band

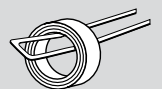

001401020ZF	290395	20 x 1,0	3 m	3,73	10 à 3 m
001401020W	290364	20 x 1,0	1,5 m	2,02	10 à 1,5 m
001403020ZF	290326	20 x 1,0	10 m	6,39	5 à 10 m

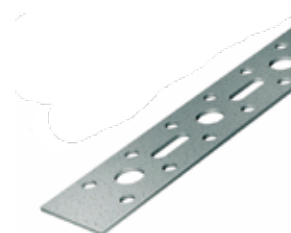

Abmessung: 20 mm

Montage-
band

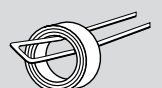

Abstandshalter

Spacers
Pièces d'écartement
Distanciadores

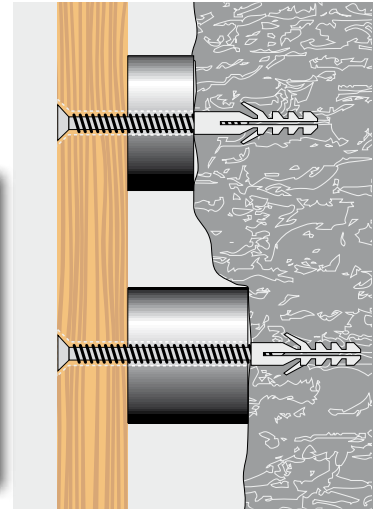

Abstands- halter aus Kunststoff



Artikel-Nr.	GTIN 4003984	Abmessungen mm			Inhalt pro Box	Verp.- Einheit ...Boxen	Aus- führung	ca. kg je VE
		A	B	C				
098001000	440322	5	20	8,5	20	5	S	0,28
098002000	440349	10	20	8,5	15	5	S	0,36
098004000	440356	20	20	8,5	10	5	S	0,38
098011000	440394	5	20	8,5	20	5	W	0,29
098012000	440400	10	20	8,5	15	5	W	0,33
lose verpackt					verpackt zu ... Stück			
001601000S	290289	5	20	8,5	100		S	0,20
		für Schrauben von Ø 5 - 8 mm						

Leiter- und Gerätehalter

Ladder- and tool-supports
Supports échelles et objets encombrants
Soportes para escaleras y utensilios



Leiter- und Gerätehalter

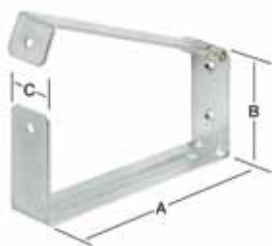

Artikel-Nr.	Ausführung	GTIN 4003984	Abmessungen mm			ca. kg je VE	Schrauben		verp. zu... Stück.
			A	B	C		Stck.	Ø mm	
001440200Z		370653	200	90	40	1,28	2 2	2,0 8,0 für Schloss	2



- alle Größen miteinander kombinierbar
- Verbindung von gerader und abgewinkelter Ausführung möglich
- zusätzliche Stabilität bei Verbindungen durch geprägtes Material



- für viele Einsatzgebiete, z.B. zum variablen Abhängen von Decken inkl. Kabelverlegung
- auch zum Einbau von Holz- und Kunststoff-Fenstern geeignet

Artikel-Nr.	Ausführung	GTIN 4003984	Abmessungen mm			ca. kg je VE	Schrauben		verp. zu... Stck.
			A	B	C		Stck.	Ø mm	
000276050Z		252089	50	70	30	3,11	1/2	M6/ M8	150
000276060Z		251983	60	70	30	5,97	2/2	M6/ M8	150
000276100Z		252072	100	70	30	7,86	4/2	M6/ M8	150
000276120Z		252034	120	70	30	8,93	5/2	M6/ M8	150
000276130Z		252041	130	70	30	9,44	6/2	M6/ M8	150
000276050ZP		251815	50	70	30	2,26	1/2	M6/ M8	6 à 10
000276100ZP		251822	100	70	30	3,26	4/2	M6/ M8	6 à 10
000276150ZP		213202	150	70	30	4,21	7/2	M6/ M8	6 à 10

000277070Z		251884	70	70	30	5,98	2/2	M6/ M8	150
000277060ZP		213219	60	70	30	2,24	1/2	M6/ M8	6 à 10
000277110ZP		213226	110	70	30	4,20	4/2	M6/ M8	6 à 10
000277160ZP		213233	160	70	30	4,26	7/2	M6/ M8	6 à 10

Verstellwinkel

geprägt,
kombinierbar für
verschiedene
Einsatzzwecke

sendzimir verzinkt



ZP=

PROFI-PACK
(Programm-
übersicht
siehe Seite 30)

Verstellwinkel

2x45°, geprägt,
kombinierbar für
verschiedene
Einsatzzwecke

sendzimir verzinkt

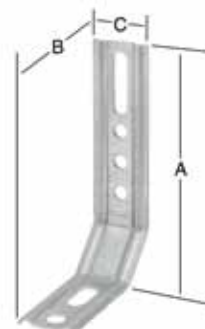

ZP=

PROFI-PACK
(Programm-
übersicht
siehe Seite 30)



Universalhaken

Universal hooks
Crochets universels
Ganchos universales

Wandhaken U-Form

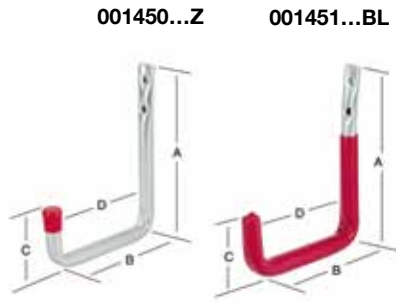

Artikel-Nr.	GTIN 4003984	Abmessungen				ca. kg je VE	Schrauben		VE	kg/ Stck.
		A	B	C	D		Stck.	Ø mm		
001450002Z	370233	125	86	53	60	0,06	2	4,5	1	35
001450004Z	370240	148	114	56	86	0,08	2	4,5	1	25
001450006Z	370257	220	144	91	105	0,16	2	4,5	1	37
001450008Z	370264	300	250	93	210	0,24	2	4,5	1	22
001451004BL	370271	145	120	60	90	0,09	2	4,5	1	25
001451006BL	370288	214	155	90	112	0,19	2	4,5	1	37
001451008BL	370295	302	255	96	212	0,28	2	4,5	1	22

Decken- haken

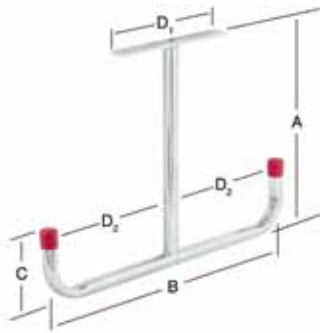

001452001Z	370301	295	435	95	180/ 184	0,48	4	4,5	1	55
------------	--------	-----	-----	----	-------------	------	---	-----	---	----

Wandhaken / Deckenhaken



001453002Z	370318	150	88	50	83	0,09	2	4,5	1	10
001453004Z	370325	245	110	72	160	0,22	4	4,5	1	20

Wandhaken



001454002Z	370332	78	175	-	-	0,06	2	4,5	1	12
------------	--------	----	-----	---	---	------	---	-----	---	----

Doppel- haken

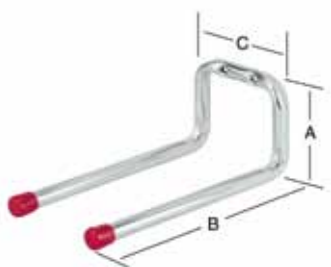

001455002Z	370349	78	195	92	-	0,15	2	4,5	1	7
------------	--------	----	-----	----	---	------	---	-----	---	---

Artikel-Nr.	GTIN 4003984	Abmessungen				ca. kg je VE	Schrauben		VE	 kg/ Stck.
		A	B	C	D		Stck.	Ø mm		
001456002Z	370356	83	27	35	15	0,05	2	4,0	1	17
001456004Z	370363	110	64	57	20	0,16	2	5,0	1	37
001456006Z	370370	175	98	87	25	0,30	2	6,0	1	35

Universalhaken

Universal hooks
Crochets universels
Ganchos universales



**Universal-
haken**

001457001BL	370387	50	60	125	90	0,17	2	4,0	1	37
-------------	--------	----	----	-----	----	------	---	-----	---	----

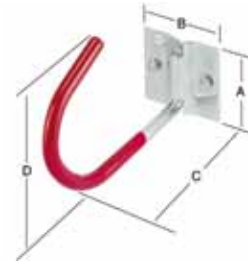

**Fahrrad-
haken**
schwenkbar

001457003BL	370714	46	80	95	100	0,13	1	5,0	1	37
-------------	--------	----	----	----	-----	------	---	-----	---	----

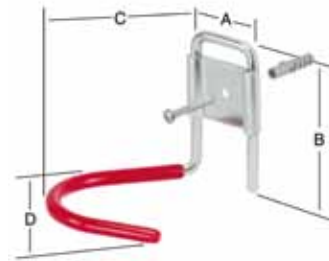

**Fahrrad-
haken**
fest

001458001Z	370394	40	328	150	231	1,17	3	4,5	1	-
------------	--------	----	-----	-----	-----	------	---	-----	---	---

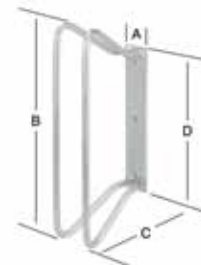

**Fahrrad-
ständer**

001460001Z	370417	150	115	87	90	0,16	2	4,5	1	30
001461001BL	370424	150	115	87	90	0,18	2	4,5	1	30

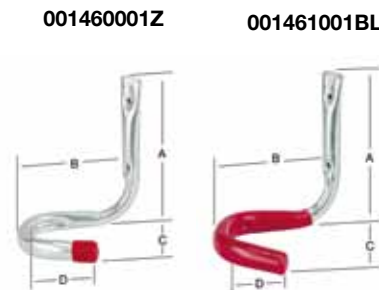

**Fahrrad-
haken**

001462000BL	370431	46	55	126	60	0,12	1	4,5	1	-
-------------	--------	----	----	-----	----	------	---	-----	---	---



**Staub-
saugerhalter**



Universalhaken

Universal hooks
Crochets universels
Ganchos universales

Surfbrett- haken mit Auflage

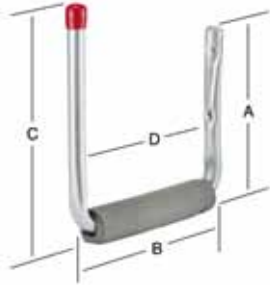

Artikel-Nr.	GTIN 4003984	Abmessungen				ca. kg je VE	Schrauben		VE	 kg/ Stck.
		A	B	C	D		Stck.	Ø mm		
001463001Z	370448	185	210	240	180	0,24	2	4,5	1	15

Universal- haken

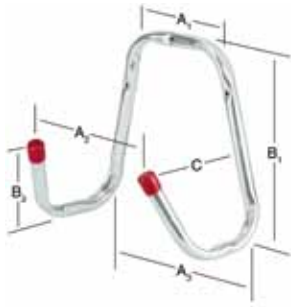

001464001Z	370455	150 185 270	240 120	105	-	0,29	3	4,5	1	72
------------	--------	-------------------	------------	-----	---	------	---	-----	---	----

Schwer- lasthaken

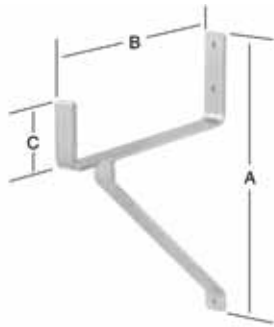

001465001Z	370462	355	245	80	-	0,91	3	4,5	1	100
------------	--------	-----	-----	----	---	------	---	-----	---	-----

Felgen- halter

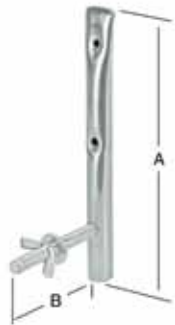

001466001Z	370479	197	88	-	-	0,14	2	4,5	1	60
------------	--------	-----	----	---	---	------	---	-----	---	----

Skihalter

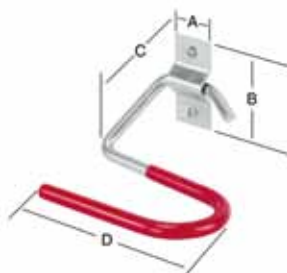

001467001BL	370486	40	60	70	130	0,21	2	4,0	1	-
-------------	--------	----	----	----	-----	------	---	-----	---	---

Artikel-Nr.	GTIN 4003984	Abmessungen				ca. kg je VE	Schrauben		VE	 kg/ Stck.
		A	B	C	D		Stck.	Ø mm		

Universalhaken

Universal hooks
Crochets universels
Ganchos universales

001469001Z	370493	165	65	48	-	0,08	-	-	1	27
------------	--------	-----	----	----	---	------	---	---	---	----

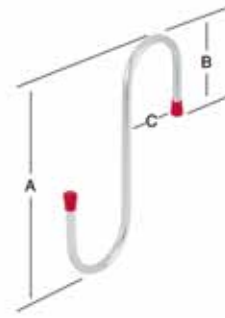

S-Haken

001470001Z	370691	260	190	86	152	0,22	2	4,5	1	15/20 ob./unt.
------------	--------	-----	-----	----	-----	------	---	-----	---	-------------------

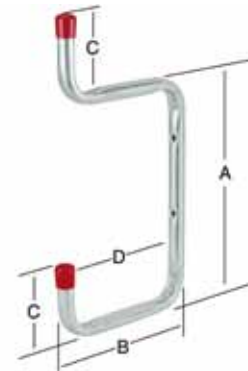

Wand- doppelhaken

001471002Z	370509	120	78	90	51	0,14	2	4,5	1	20
001471004Z	370516	120	172	90	142	0,19	2	4,5	1	27
001471006Z	370523	120	247	90	218	0,23	2	4,5	1	17
001471008Z	370530	120	314	90	287	0,28	2	4,5	1	12

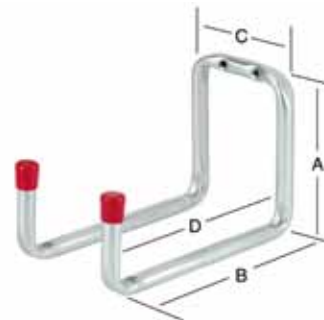

Gerätehalter

001472002Z	370547	120	90	195	55	0,21	2	4,5	1	15
001472004Z	370554	120	90	395	55	0,31	2	4,5	1	13

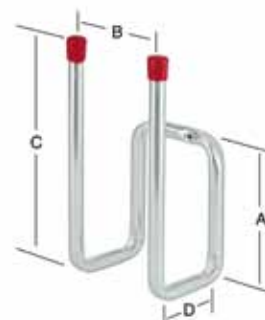

Stiefelhalter



Universalhaken

Universal hooks
Crochets universels
Ganchos universales

Universalhaken

schwenkbar

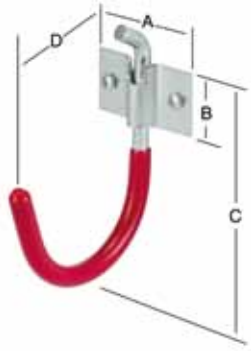

Artikel-Nr.	GTIN 4003984	Abmessungen				ca. kg je VE	Schrauben		VE	kg/ Stck.
		A	B	C	D		Stck.	Ø mm		
001475001BL	370578	60	30	125	80	0,13	2	4,0	1	45

Wandhaken, L-Form



001476002Z	370585	177	155	-	-	0,11	2	4,5	1	30
001476004Z	370592	177	347	-	-	0,20	2	4,5	1	12

Zaunriegelhalter

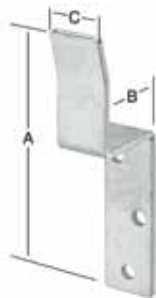

001478000Z	370721	160	37	30	-	3,55	3	8,0	20	-
------------	--------	-----	----	----	---	------	---	-----	----	---

Manschettenhaken



Artikel-Nr.	Ausführung	GTIN 4003984	Abmessungen mm			ca. kg je VE	Schrauben		verp. zu... Stck.
			A	B	Stärke		Stck.	Ø mm	
000292050Z		370196	-	ø 50	-	1,61	-	-	4
000292100Z		370202	-	ø100	-	2,42	-	-	4
000292120Z		370189	-	ø120	-	2,77	-	-	4

Halterungs-Set Festzeltgarnitur



Artikel-Nr.	GTIN 4003984	Abmessungen				ca. kg je VE	Schrauben		verp. zu... Stck.
		A	B	C	D		Stck.	Ø mm	
001477000Z	370684	370 280	80/ 160	40	-	3,00	8	6,0	5



Halterungs-Set Festzeltgarnitur

inkl. Schrauben und Dübel
passend für 2 Bänke und 1 Tisch

000242001Z	601986	72	60	-	-	0,70	5/1	5,0	6
------------	--------	----	----	---	---	------	-----	-----	---



Ersatz-schnäpper für Festzeltgarnitur

Artikel-Nr.	GTIN 4003984	Abmessungen mm			ca. kg je VE	Schrauben		verp. zu... Stck.	kg Stck.
		A	B	Draht		Stck.	Ø mm		
010290001	570107	52	55	4,8	0,63	2	5,5	10	20
010290002	570091	120	55	4,8	0,85	2	5,5	10	15

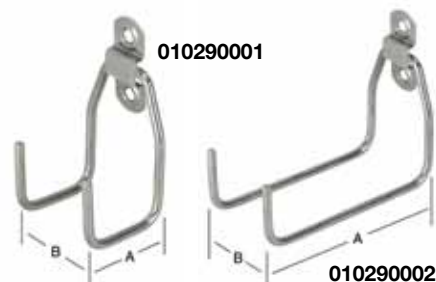

Universal-Halter





Diverse Halter

Supports
Supports
Sujetadores

Ösenplatten (Vielweckschlaufen)



Artikel-Nr.	Ausführung	GTIN 4003984	Abmessungen mm			ca. kg je VE	Schrauben		verp. zu... Stck.
			A	B	Stärke		Stck.	Ø mm	
000075035Z 000075075Z		080361	35	25	2,0	0,80	4	3,5	25
		080378	44	41	2,5	0,38	4	6,0	5
010075035	Rost frei V2A	180351	35	25	2,0	0,62	4	3,5	20

Ösenplatten (Vielweckschlaufen)



000076040Z 000076045Z		080385	40	28	1,0	0,41	2	3,0	25
		080392	45	31	1,25	0,62	2	3,0	25

Rohr- schellen

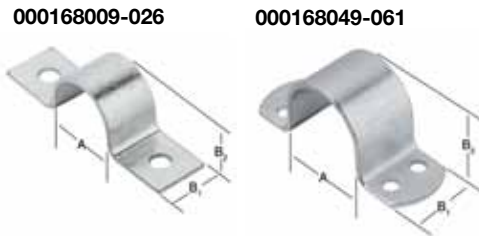

000168009Z		290418	B ₁	15	1,50	0,24	2	5,0	25
			B ₂						
000168013Z		290449	3/8"	15	1,50	0,27	2	5,0	25
			13						
000168019Z		290432	1/2"	15	1,50	0,35	2	5,0	25
			10						
000168026Z		290425	3/4"	20	2,0	0,80	2	5,0	25
			16						
000168049Z		290661	1"	40	3,0	1,55	4	8,0	10
			22						
000168061Z		290685	1 3/4"	40	3,0	1,87	4	8,0	10
			45						
			2"	40	3,0	1,87	4	8,0	10
			55						

Riegel- schlaufen mit Vierkantlöchern

passend für Riegel
000109160ZF
000109180ZF
000111400Z
000111500Z
000111600Z



000169018ZF		201278	18	24	2,0	1,56	2	5,0	50
-------------	--	--------	----	----	-----	------	---	-----	----

Riegel- schlaufen

(Montageschlaufen)
mit Schraublöchern



000170014Z		201872	14	7	1,2	0,54	2	3,0	100
000170020Z		200059	20	11,5	2,0	0,43	2	4,0	25
000170025Z		200066	25	12	2,0	0,53	2	4,0	25
000170030Z		201803	30	14	2,5	0,69	2	5,0	25
000170034Z		200073	34	16	2,5	1,36	4	5,0	25

Artikel-Nr.	Ausführung	GTIN 4003984	Abmessungen mm			ca. kg je VE	Schrauben		verp. zu... Stck.
			A	B	Stärke		Stck.	Ø mm	
000280001Z		570022	49	15	3,5	0,41	2	4,0	10
000280002Z		570046	36 65 87	17 35 17	3,5	0,82	2	4,0	10
000280001W		570015	49	15	3,5	0,43	2	4,0	10
000280002W		570053	36 65 87	17 35 17	3,5	0,82	2	4,0	10



Wandhaken

000283003Z		570039	120 63	17 48	3,5	1,75	2	4,0	20
------------	--	--------	-----------	----------	-----	------	---	-----	----



Wandhaken

010255000		570114	74	32	1,25	1,09	1 rd. 1	5,0 16 x 5	50
-----------	---	--------	----	----	------	------	------------	---------------	----



Edelstahl-Aufhänge-lasche

000270002Z Länge/ØStift		290227	55 60	20	3,0 7,8	2,12	1	6,0	50
----------------------------	--	--------	----------	----	------------	------	---	-----	----

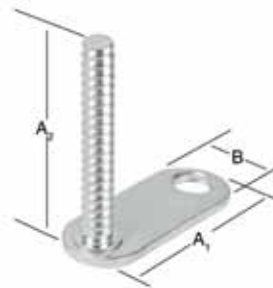

Bolzen-verbinder

versenktes Loch
– Vorbohren
– Einschlagen
– Verbinden

000254000Z (links)		290173	75	18	2,0	2,06	7	3,0	50
000254001Z (rechts)		290197	75	18	2,0	2,06	7	3,0	50
000254002Z (links)		290654	75	12	1,5	1,04	4	3,0	50
000254003Z (rechts)		290647	75	12	1,5	1,04	4	3,0	50
000254000ZL		290180	75	18	2,0	9,99	7	3,0	250
000254001ZL		290203	75	18	2,0	9,99	7	3,0	250
000254002ZL		290708	75	12	1,5	4,96	4	3,0	250
000254003ZL		290715	75	12	1,5	4,96	4	3,0	250



Aufhänge-winkel

für Bilderrahmen,
Hängeschränke

Abbildung
Aufhängung links



Handlaufstützen

Handrail supports
Appuis de main courante
Soportes des pasamanos

Handlauf- stütze 90°

verstellbar
mit Abdeckrosette
mit gewölbter
Auflageschale

Wandabstand 70 mm



Artikel-Nr.	GTIN 4003984	Abmessungen				ca. kg je VE	Schrauben		VE
		A	B	C	D		Stck.	Ø mm	
006010090RF V2A	6204345	75	-	-	-	1,85	3/2	5,5/3,5	8

Handlauf- stütze 90°

fest
mit Abdeckrosette
mit gewölbter
Auflageschale

Wandabstand 70 mm



006011090RF	620352	75	-	-	-	1,88	3/2	5,5/3,5	8
006011090RG V2A	103206	75	-	-	-	11,00	3/2	5,5/3,5	50
006011090WA	620512	75	-	-	-	1,94	3/2	5,5/3,5	8
006011090W	620505	75	-	-	-	1,95	3/2	5,5/3,5	8
006011090Z	622110	75	-	-	-	1,95	3/2	5,5/3,5	8

Handlauf- stütze 90°

fest
mit gewölbter
Auflageschale

Wandabstand 70 mm



006012090RF V2A	620437	47	-	-	-	2,76	2/2	6/3,5	16
------------------------	--------	----	---	---	---	------	-----	-------	----

Handlauf- stütze 90°

mit gewölbter
Auflageschale
und
Stockschraube M8

Wandabstand 70 mm



006013090RF V2A	620925	75	-	-	-	1,89	1/2	6/3,5	8
------------------------	--------	----	---	---	---	------	-----	-------	---

Handlauf- stütze gerade

verstellbar
mit Abdeckrosette
mit gewölbter
Auflageschale

Wandabstand 60 mm

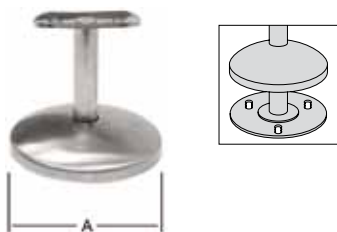

006017000RF V2A	620338	75	-	-	-	1,59	3/2	5,5/3,5	8
------------------------	--------	----	---	---	---	------	-----	---------	---

Handlauf- stütze 90°

verstellbar
mit M8 Gewinde
mit Abdeckrosette

Wandabstand 70 mm



006020090RF V2A	620369	75	-	-	-	1,83	3	5,5	8
006021090RF	620376	75	-	-	-	1,72	3	5,5	8
006021090RG V2A	103190	75	-	-	-	10,48	3	5,5	50

Handlaufstützen

Handrail supports
Appuis de main courante
Soportes des pasamanos Banisters supports

Artikel-Nr.	GTIN 4003984	Abmessungen				ca. kg je VE	Schrauben		VE
		A	B	C	D		Stck.	Ø mm	
006022090RF  V2A	620444	47	-	-	-	2,64	2	6,0	16



Handlauf- stütze 90°

fest
mit M8 Gewinde

Wandabstand 70 mm

006027000RF  V2A	620383	75	-	-	-	1,51	3	5,5	8
---	--------	----	---	---	---	------	---	-----	---

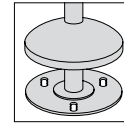

Handlauf- stütze gerade

verstellbar
mit M8 Gewinde
mit Abdeckrosette

Wandabstand 60 mm

006030090RF 006032090RF  V2A	668576 668583	75 75	- -	40 42,4	- -	1,83 1,83	3 3	5,5 5,5	8 8
--	------------------	----------	--------	------------	--------	--------------	--------	------------	--------

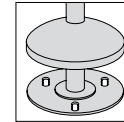

Handlauf- stütze 90° mit Schelle

für
Holzhandläufe

Wandabstand 70 mm

für Edelstahl-
handläufe

Wandabstand 70 mm

006111090RF  V2A	101615	75	-	-	-	1,60	3/2	5,5/3,5	8
---	--------	----	---	---	---	------	-----	---------	---



Handlauf- stütze 90°

fest
ohne Abdeckrosette
mit gewölbter
Auflageschale

Wandabstand 70 mm

006121090RF  V2A	101622	75	-	-	-	1,86	3	5,5	8
---	--------	----	---	---	---	------	---	-----	---



Handlauf- stütze 90°

fest
mit M8 Gewinde
ohne Abdeckrosette

Wandabstand 70 mm

Artikel-Nr.	Ausführung	GTIN 4003984	Abmessungen mm			ca. kg je VE	Schrauben		verp. zu... Stck.
			A	B	Stärke		Stck.	Ø mm	
000350001Z		290456	63	65	2,0	1,62	3	5,0	10
000350001W		290470	63	65	2,0	1,62	3	5,0	10
Auflage			70	20	3,0				



Geländer- stützen

fest
mit gerade
Auflageschale

Hier noch einmal auf einen Blick alle Profi-
Halter.



und Großpacks



aus dem Sortiment Winkel/Verbinder/
Halter.

GB

Here you will find once more an
overview of all industrial and bulk
packs from our range of angles/
connectors/brackets and holders.

F

Retrouvez ici une fois encore et en un seul
coup d'oeil l'ensemble des conditionnements
de la gamme „equerres/connecteurs/supports,
pour gros utilisateurs et professionnels.

E

Aquí un resumen de todos los
paquetes profesionales y grandes
del surtido escuadras/placas de
conexión/soportes.

Stuhlwinkel



(000181...)

Artikel-Nr. GTIN 4003984	Abmessungen mm		Stärke	verp. zu
	A ₁ A ₂	B B ₂		
000180025ZP 201827	25	15	2,0	10à12
000180030ZP 201834	30	15	2,0	10à12
000180040ZP 201841	40	15	2,0	10à12
000180050ZP 201858	50	15	2,0	10à12
000180060ZP 201865	60	18	2,0	10à8
000180080ZP 201889	80	18	2,0	10à8
000181100ZP 201902	100	20	2,5	10à8
000180025ZG 202008	25	15	2,0	1à50
000180040ZG 202015	40	15	2,0	1à50
000180050ZG 202022	50	15	2,0	1à50
000180060ZG 202039	60	18	2,0	1à50

Spanplattenwinkel



Artikel-Nr. GTIN 4003984	Abmessungen mm		Stärke	verp. zu
	A ₁ A ₂	B B ₂		
000174005ZP 202084	40	19	1,5	10à12

Verbindungsbleche



000183080ZP 202091	80	15	2,0	10à8
000183100ZP 202107	100	15	2,0	10à8

Breitwinkel



000177030ZP 201957	30	30	2,0	6à12
000177040ZP 201964	40	40	2,0	4à12

Verstellwinkel



000174002ZP 201940	25	30	1,0	6à12
-----------------------	----	----	-----	------

Starke Winkel



000182040ZP 201988	40	20	3,0	6à8
000182060ZP 201995	60	20	3,0	6à8

Verstellwinkel



Artikel-Nr. GTIN 4003984	Abmessungen mm			verp. zu
	A ₁ A ₂	B B ₂	C	
000276050ZP 251815	50	70	30	6à10
000276100ZP 251822	100	70	30	6à10
000276150ZP 213202	150	70	30	6à10

**Starke
Balkenwinkel**



000179100ZP 201971	100 75	30	3,0	6à8
-----------------------	-----------	----	-----	-----



000277060ZP 213219	60	70	30	6à10
000277110ZP 213226	110	70	30	6à10
000277160ZP 213233	160	70	30	6à10

Vertreter / Ansprechpartner Inland:

Michael Wolfs
Nordstraße 32-34
52353 Düren
Tel.: 02421-7607843
Mobil-Tel.: 0173-5455549
m.wolfs@vormann.com

Edwin Benischke
Inh. Alexander Löh e.K
Grasiger Weg 11
90518 Altdorf
Tel.: 09187-959554
Fax: 09187-808296
Mobil-Tel.: 0172-9026677
edwin.benischke@onlinehome.de

Dietmar Sarnes
Aschhofen 16
83620 Feldkirchen-Westerham
Fax: 08063-2007128
Mobil-Tel.: 0163-8312020
dietmar.sarnes@web.de

Trudo Pfahl
Werksvertretung
Bachenauer Str. 15
74254 Offenau
Tel.: 07136-970380
Fax: 07136-970382
Mobil-Tel.: 0172-6688507
trudo.pfahl.wv@t-online.de

WMS
Jürgen Bürck
Nachtigallenweg 30
74855 Hassmersheim
Tel.: 06266-7775
Fax: 06266-7778
Mobil-Tel.: 0171-5321156
wms1jb@aol.com

Solibieda
Vertriebs- und Service GmbH
Höfkerstraße 27
44149 Dortmund
Tel.: 0231-9172230
Fax: 0231-91722320
solibieda@solibieda.de

Jörg Lang
Zur Heide 19
16348 Wandlitz
Tel.: 0231-9172230
Fax: 03222-1565100
Mobil-Tel.: 0171-5154962
joerg.lang@solibieda.de

Nur Fachhandel

 Rosendahl & Koppel
Inh.: M. Petersen
Bahnhofstr. 15
21465 Reinbek bei Hamburg
Tel.: 040/234147
Fax: 040/233691
Mobil-Tel.: 0171-8063050
mark.petersen@roko-petersen.de

Karl Kregeler
Werksvertretungen
Herrendienstweg 71
32120 Hiddenhausen
Tel.: 05221-96900
Fax: 05221-969030
Mobil-Tel.: 0171-8547763
info@kregeler-
werksvertretungen.de

Rufen Sie uns an und wir nennen Ihnen Ihren zuständigen Außendienstmitarbeiter unter 0 23 33/978-0

Vertreter / Ansprechpartner Ausland:

Afrika
August Vormann SA (PTY) LTD.
P.O. Box 4545
ZA 6539 George East
Tel.: 0027-44-8781441
Fax: 0027-44-8781408
info@vormann.co.za

Belgien
Husquin & Co SA
Ikaroslaan 69
B-1930 Nossegem-Zaventem
Tel.: 0032-2-2620900
Fax: 0032-2-2685241
info@husquin.com

Dänemark
Roliba A/S
Hvidkaervej 52
DK-5250 Odense
Tel.: 0045-65930357
Fax: 0045-65932757
e-mail: post@roliba.dk

Estland
HeWood OÜ
Haapsalu mnt 21
EE-76605 Keila, Harjumaa
Tel.: 00372 53595155
tellimine@hewood.ee

Frankreich
Christophe Isoux
ADF DIFFUSION
1, rue de la Jaunaie
F-35500 Vitre
Tel.: 0033-256538305
Mobil-Tel.: 0610137139
Fax: 0033-253596055
Email: adfisoux@aol.com

Griechenland
Voyatzoglou Systems S.A.
12 Km. Nat. Road Athens-Lamina
GR-14451 Metamorfoosi-Athens
Tel.: 0030-2102888600
Fax: 0030-2102888699
info@voyatzoglou.gr
www.voyatzoglou.gr
www.visitgreece.gr

Lettland
SB & Partneri
Renčenu iela 21 2.St.
LV-1073, Riga
Tel.: 00371-67113070
info@sbunpartneri.lv

Niederlande
Ruro Gereedsschappen B.V.
Vestingdok 4
NL-3433 KR Nieuwegein
Tel.: 0031-30 608 42 42
Fax: 0031-30 608 17 69
info@ruro.nl
www.ruro.nl

Österreich
Christian Altenhofer
Kokoschka Straße 31
A-4020 Linz
Tel.: 0043-6642147423
ch.altenhofer@liwest.at

Pohl & Co GmbH & Co. KG
Metallwarenerzeugung
Zeller Str. 3
A-4600 Wels
Tel.: 0043-724246673
Fax: 0043-724242160
office@pohl.co.at

Polen
Aspeo sp.z o.o.
ul. Dąbrowskiego 97C/5
PL - 60-574 Poznań
Tel.: 0048-61-6463252
Fax: 0048-61-6463258
info@aspeo.pl
www.aspeo.pl/pl

Rumänien
EuroNarcis
Str. Muresului nr. 1A
RO-547526 Nazna, jud. Mures
Tel.: 0040-265320013
Fax 0040-265320083
office@euronarcis.ro

Russland
OOO "GTL" RUSSIA
Yl.3-Sovetskay, de 11, lit A, pom 1H
RUS-193015 St. Petersburg
Tel.: 007-812-4599847
Fax: 007-812-4599848
manager.one@gtl.spb.ru

Schweiz
SFS unimarket AG
Rosenbergsaustrasse 4
CH-9435 Heerbrugg
Tel.: 0041-714242151
Fax: 0041-717275499
info@sfs.ch

Etter + Co. AG
Espenmatt 1
CH-9220 Bischofszell
Tel.: 0041-714242121
Fax: 0041-714242131
mail: info@webi.ch

Slowenien
Zelezna Hudoavernik d.o.o.
Partizanska c. 2
SLO-3320 Velenje
Tel.: 00386-3898 23 50
Fax: 00386-3898 23 60
info@zelezna.si

Tschechien
Dastech s.r.o.
Delnická 57
CZ-41712 Probošov
Tel./Fax: 00420-417 532 894
Mobil-Tel.: 00420-603 170 967
dastech@seznam.cz
www.dastech.cz

Jiří Dušek
Porická 716/8
CZ-198 00 Praha 9
Mobil-Tel.: 00420-603 439 308
jirha@seznam.cz

Ungarn
Tamas Györe
Cibkháza u. 78/1
HU-1162 Budapest
Tel.: 0036-704288228
gyore.tamas@gmail.com

VORMANN
SCHARNIERE · BESCHLÄGE



August Vormann GmbH & Co. KG
Postfach 15 52
58244 Ennepetal

Heilenbecker Str. 191 -205
58256 Ennepetal
Deutschland / Germany

Telefon : ++49 (0) 2333 / 978 - 0
Telefax : ++49 (0) 2333 / 978 - 241599
www.vormann.com
E-Mail: info@vormann.com



Art-Nr. 089500054AV



4 003984 893916